

2542 LI - utskiftbare/exchangeable AC plugs

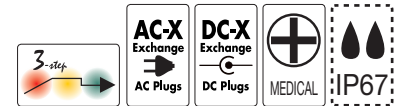

- 3-trinns ladekontroll med strømdeksjon som ladestopp
 - Switch mode lader med universal inngangsspenning (90-264 VAC)
 - Opplading av 1-8 Li-Ion battericeller
 - Tilfredsst. medisinsk std (EN 60601)
 - 3-farget lysdiode indikator
 - 2-pins IEC 320 nettkontakt
 - Nettledning ikke inkludert
 - Tilpasninger leveres på forespørsel
- 3-step charge control with current detection as charge termination
 - Switch mode charger with universal input voltage (90-264 VAC)
 - Charging 1-8 Li-Ion battery cells
 - Complies w. medical std (EN 60601)
 - 3-colored LED indicator
 - 2-pin IEC 320 input connector
 - Mains cord not included
 - Custom specifications on request



Tekniske data	Technical specifications	
Inngangsspenning	Input voltage	90-264 VAC
Frekvensområde	Line Frequency	47 – 63Hz
Svitsjefrekvens ca.	Switch frequency, approx.	40 kHz
Strømtrekk fra batteri ved frakoblet nett:	Leakage current from battery with mains switched off:	<250µA
Temperaturområde	Temperature range	
• drift	• operating	-20 °C - +40 °C
• lagring	• storage	-25 °C - +85 °C
Rippel	Ripple	< 100 mV p-p
Virkningsgrad (100% last, 230V)	Efficiency (at 100% load, 230V)	
Sikring	Protection	Polvendings- og kortslutningssikker Protected against reversed polarity and short circuit proof
Isolasjonsklasse	Insulation class	II
Isolasjonsspenning	Insulation voltage	
Primær - sekundær:	Primary – secondary:	4000VAC / 5700VDC
Elektrisk sikkerhet	Electrical safety	EN 60601-1, EN 60950-1, EN 60335-2-29
EMC standarder	EMC standards	
• Medisinsk	• Medical	EN 60601-1-2
• Emisjon	• Emission	EN 61000-6-3
• Immunitet	• Immunity	EN 61000-6-1
Inngangsterminal:	Input terminal:	2-pins IEC 320 connector
Utgangsterminaler:	Output terminals:	Sekundærledning med / uten plugg. Cord with/without plug.
IP-Grad:	IP-code:	41
Mål (LxBxH)	Dimensions (LxWxH)	107 x 67 x37mm
Vekt	Weight	250g

Versjoner - Versions

Celler	Max utg. effekt Max output power (W)	Virkningsgrad Efficiency (100% at 230V)	Ladekontroll - charge control				Ladestart Vbat<	
			Step 1 (orange)	Step 2a (orange)	Step 2b (gul/yellow)	Step 3 (grønn/green)		
Cells			Ladestrøm	Ladespenning	Til Gul når strøm er:	Ladestopp når strøm er:	Ladestart Vbat<	
			Charge Current	Charge Voltage	To yellow when current is:	Charge Termin. when current is:	Charge start Vbat<	
1	12	63 %	2,7A ±0,1A	4,2V ±0,05V	< 1,15A ±0,1A	< 100mA +-25%	4,0V±0,1V	Eller nettpåslag Or mains turned on
2	23	78 %	2,7A ±0,1A	8,4V ±0,1V	< 1,15A ±0,1A		8,0V±0,1V	
3	29	83 %	2,3A ±0,1A	12,6V ±0,1V	< 1,00A ±0,1A		12,1V±0,1V	
4	34	84 %	2,0A ±0,1A	16,8V ±0,1V	< 0,85A ±0,1A		16,2V±0,1V	
5	34	85 %	1,6A ±0,1A	21V ±0,1V	< 0,70A ±0,1A		20,3V±0,1V	
6	35	87 %	1,4A ±0,1A	25,2V ±0,1V	< 0,60A ±0,1A		24,4V±0,1V	
7	35	87 %	1,2A ±0,1A	29,4V ±0,1V	< 0,50A ±0,1A		28,5V±0,1V	
8	34	85 %	1,0A ±0,1A	33,6V ±0,1V	< 0,40A ±0,1A		32,6V±0,1V	
10	35	85 %	0,8A ±0,1A	42,0V ±0,2V	< 0,35A ±0,1A		40,7V±0,4V	
14	35	85 %	0,6A ±0,1A	58,8V ±0,3V	< 0,25A ±0,05A		57,1V±0,5V	

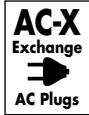

Exchangeable AC plug models

Modeller med utskiftbare AC plugger

Available as – Tilgjengelig som:

Small housing / liten boks		
Base model – Grunnmodell		W exch. AC plug
Type	Description – Beskrivelse	Type
2121	AC/DC PSU, max 10W	2123
2124	AC/DC PSU, max 16W	2126
2115	NiMH battery charger, max 1,3A	2116
2240	Lead Acid batt. chrg, max 1,3A	2241
2240 LI	Li-Ion batt. chrg, max 1,3A	2241 LI
Additional housing weight (excl. Plug/cord) +15 g Tilleggsvekt (uten plugg/ledning) +15 g		

Medium housing / medium boks		
Base model – Grunnmodell		W exch. AC plug
Type	Description – Beskrivelse	Type
9921	AC/DC PSU, max 40W	9926
2720	AC/DC PSU, max 40W	2721
2541	Lead Acid batt. chrg, max 2,2A	2542
9940	Lead Acid batt. chrg, max 2,3A	9941
2215	NiMH battery charger, max 35W	2216
9940 LI	Li-Ion batt. chrg, max 2,3A	9941 LI
2541 LI	Li-Ion batt. chrg, max 2,7A	2542 LI
Additional housing weight (excl. Plug/cord) +27 g Tilleggsvekt (uten plugg/ledning) +27 g		

IEC 320 mains cord / nettleledning 1800mm EU part no. 131306,
 UK part no. 131148, US part no. 131147, AU part no. 013108



EXCHANGEABLE AC PLUG ADAPTERS

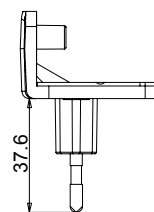
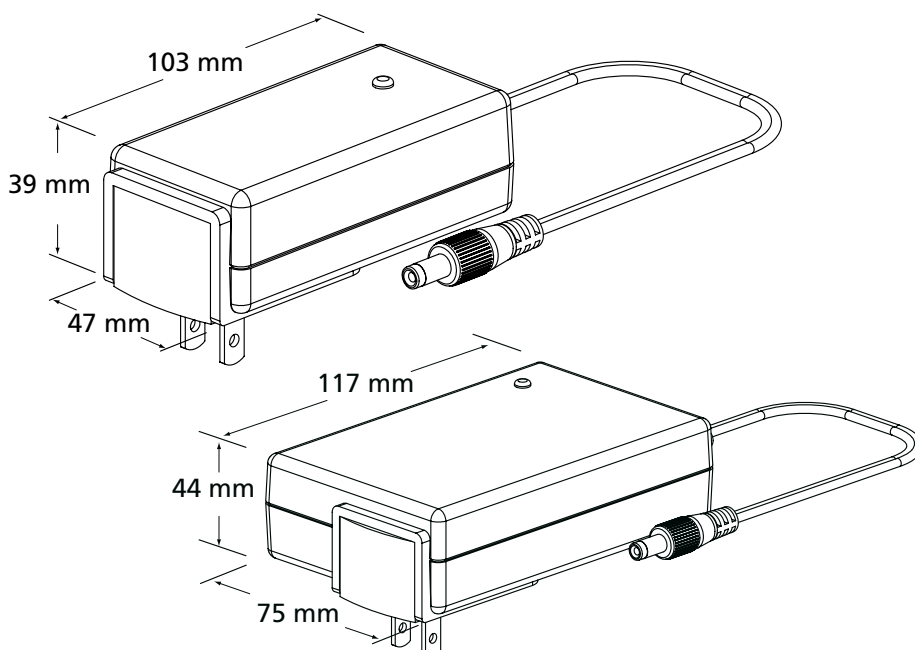

EU plug
 part no. 018110
 Weight: 21g

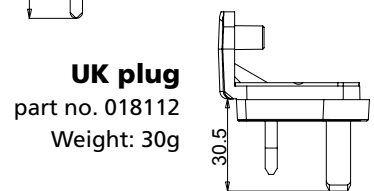

UK plug
 part no. 018112
 Weight: 30g

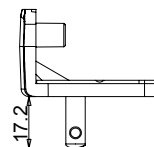

US plug
 part no. 018111
 Weight: 14g

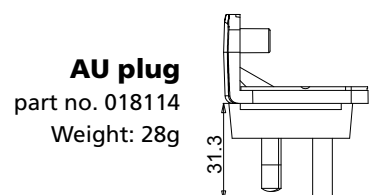

AU plug
 part no. 018114
 Weight: 28g