



DCG77-12



CYCLING CAPACITY

20 Hour Rate **77 Amp Hours**

RESERVE CAPACITY

Reserve @25 AMPS **132 Minutes** Reserve @75 AMPS **33 Minutes**

ELECTRICAL SPECIFICATIONS

Nominal Voltage	12 Volt
C100	85 AH
C20	77 AH
C10	70 AH
C5	66 AH
C3	57 AH
C2	52 AH
C1	47 AH
Internal Resistance	8.3m Ω

MECHANICAL SPECIFICATIONS

Group Size	24	
Terminal Type	M6	
Terminal Torque	See reverse side	
Height (w/ terminal)	9.65"	245 mm
Height (case only)	8.31"	211 mm
Width	6.65"	169 mm
Length	10.24"	260 mm
Weight	53.4 lbs	24.2 kg
Case Type	ABS Plastic - Flame Res. Rating UL94-HB	

DISCHARGE TABLE (Constant Current)

Time	Amps	Rate
20hr	3.9	0.05 CA
10hr	7.0	0.10 CA
8hr	8.4	0.13 CA
5hr	13.2	0.25 CA
3hr	19.0	0.33 CA
2hr	26.0	0.50 CA
1hr	47.0	1.00 CA

DISCHARGE PROFILE (Constant Current)

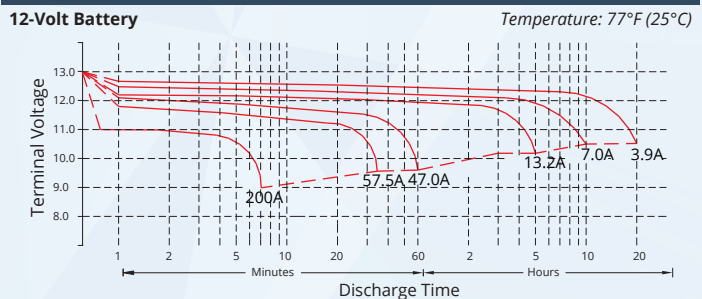

- All listed ratings are @ 100% SoC, T=77°F (25°C), 1.75VPC unless otherwise specified.
 - Specifications listed are for estimation purposes only. Battery performance can vary depending on application. Battery design subject to change.

BATTERY & TERMINAL DIMENSIONS (All units shown in mm)

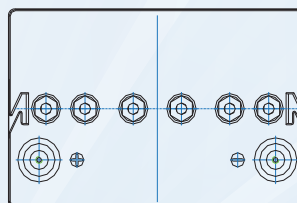
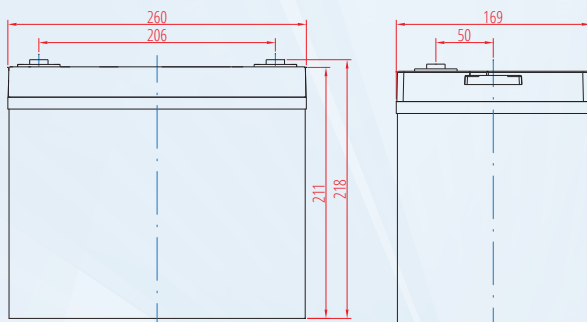

Terminal: M6

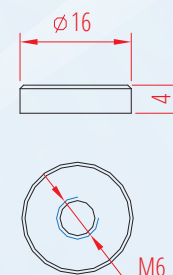

DCG SERIES | DEEP CYCLE GEL

fullriverbattery.com

TEMPERATURE vs CAPACITY

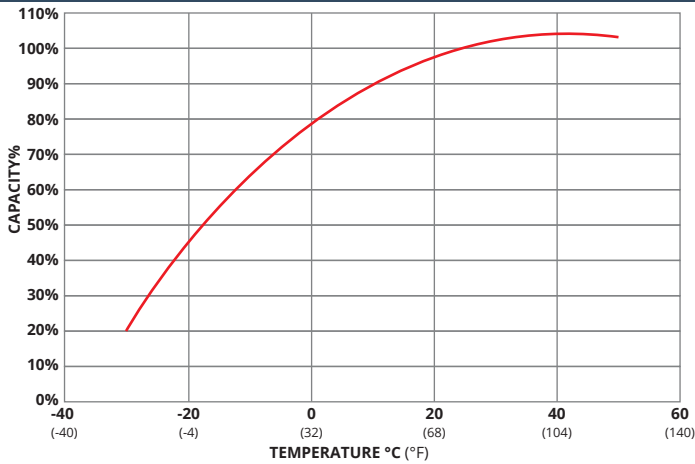

STATE of CHARGE (SOC) vs OPEN CIRCUIT VOLTAGE (OCV)

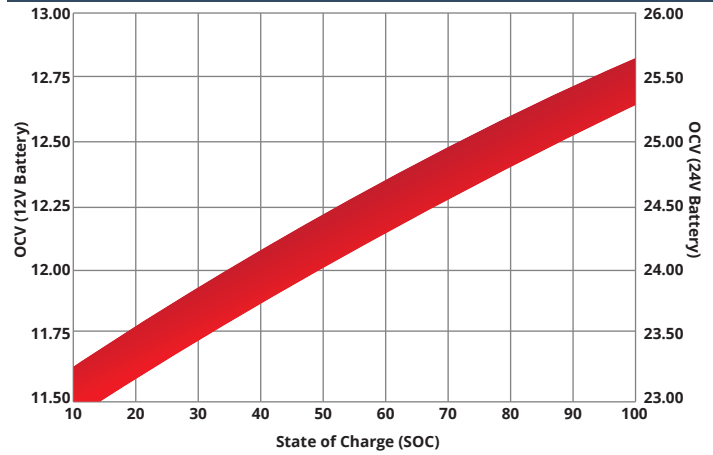

CYCLE LIFE vs DEPTH of DISCHARGE (DOD) *(Based on BCI Testing @ 2-hr Rate)

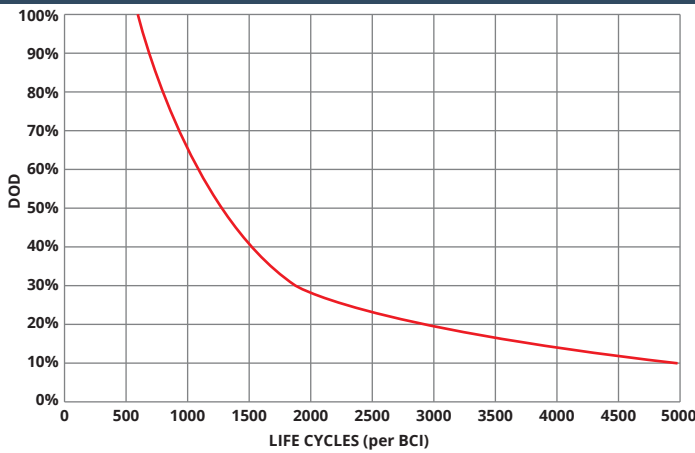

SELF DISCHARGE vs TIME/TEMPERATURE

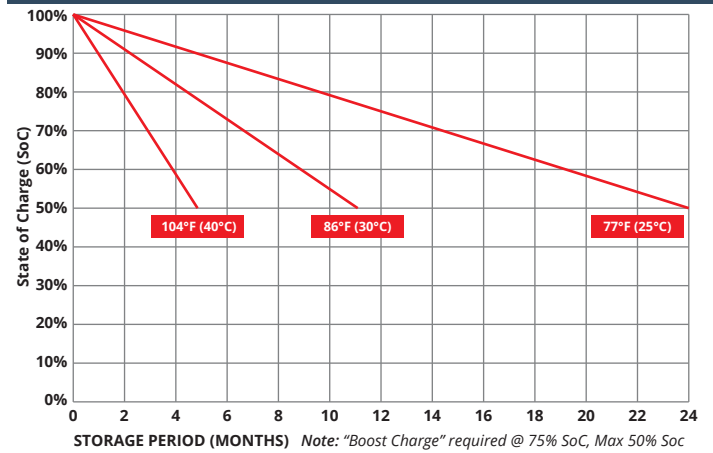

TEMPERATURE RANGE SPECIFICATIONS

Condition	Recommended	Maximum	Recommended	Maximum
Storage	5°F to 122°F	-40°F to 160°F	-15°C to 50°C	-40°C to 71°C
Operation	5°F to 104°F	-40°F to 160°F	-15°C to 40°C	-40°C to 71°C
Charge with TC	5°F to 122°F	-40°F to 160°F	-15°C to 50°C	-40°C to 71°C
Charge w/o TC	32°F to 104°F	5°F to 122°F	0°C to 40°C	-15°C to 50°C

*TC= Temperature Compensation

CHARGE VOLTAGES

Charge Stage	Battery Voltages			
	12V	24V	36V	48V
Bulk	14.1 - 14.4V	28.2 - 28.8V	42.3 - 43.2V	56.4 - 57.6V
Absorption	14.1 - 14.2V	28.2 - 28.4V	42.3 - 42.6V	56.4 - 57.0V
Float	13.6V	27.2V	40.8V	54.4V

TC Factor: (-2mV°F/cell) or (-4mV°C/cell)

TERMINAL TORQUE SPECS (applicable values are highlighted)

M6	M8	M10	M6M (Stud)	M8M (Stud)	M10M (Stud) & 3/8" Stud	FR45	TP06 (AP)	TP08/TP68 (AP)	AP
3.3-4.8ft-lbs	5.2-6.7ft-lbs	8.1-10.3ft-lbs	2.6-3.7ft-lbs	4.4-5.9ft-lbs	7.4-8.8ft-lbs	4.8-6.3ft-lbs	2.6-3.3ft-lbs	4.6-6.3ft-lbs	4.2-5.8ft-lbs
40-57.5lbs-in	62-80lbs-in	97-124lbs-in	31-44lbs-in	53-71lbs-in	88.5-106lbs-in	57-75lbs-in	31-40lbs-in	55-75lbs-in	50-70lbs-in
4.5-6.5Nm	7-9Nm	11-14Nm	3.5-5Nm	6-8Nm	10-12Nm	6.5-8.5Nm	3.5-4.5Nm	6.2-8.5Nm	5.6-7.9Nm



9001:2008 Quality Management System
 14001:2004 Environmental Management System
 18001:2007 Occupational Health & Safety Management System



DELIVERY APPROVED!
**LAND, SEA
 & AIR**

Fullriver batteries are sealed lead acid batteries made with Absorbed Glass Mat (AGM) technology. The electrolyte is absorbed into the fiberglass separator material rather than in a free-flowing liquid form. Fullriver batteries are non-spillable electric storage batteries. They are exempted from the requirements of DOT's hazardous materials regulations, since they adhere to the requirements of code 49 CFR Section 173.159(D) - (CLASSIFIED APPROVED: DOT, CFR, HMR49, IATA, ICAO67, IMDG27)