

# KB12110EV 12V 106Ah C<sub>3</sub>



The Electric Vehicle batteries were developed based on a specialized grid as well as active material. These batteries have anchored plates and a high impact reinforced polypropylene case which can withstand the most extreme environments and vibrations. The KB EV series is constituted of batteries of several different sizes so that they may be used for many different applications. The KB EV series uses dry cell technology that allows for a superior performance and an unparalleled quality and reliability. Through the use of the dry cell technology this series was designed for sensitive environments that require improved life cycles for commercial, industrial, residential and private applications. Without any need for maintenance and with an advanced construction the EV series is an excellent option for many applications.



## Dimensions and Terminal (Unit: mm (inches))

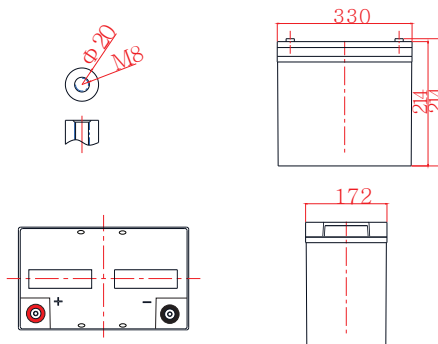

## Performance Characteristics

Nominal Voltage	12V		
Dimensions	Length (mm / inch)	330 / 12.9	
	Width (mm / inch)	172 / 6.77	
	Height (mm / inch)	214 / 8.43	
	Total Height (mm / inch)	214 / 8.43	
Approx. Weight (Kg / lbs)	33.2 / 73.3		
Design Life	5 years		
Terminal	M8		
Container Material	ABS		
Rated Capacity	118 Ah / 11.8 A	(10hr, 1.75V / cell, 20°C / 77°F)	
	106 Ah / 35.3 A	(3hr, 1.75V / cell, 20°C / 77°F)	
	82.9 Ah / 82.9 A	(1hr, 1.75V / cell, 20°C / 77°F)	
Operating Temp. Range	Discharge : -20 ~ 50°C (-4 ~ 122°F)		
	Charge : -20 ~ 50°C (-4 ~ 122°F)		
	Storage : -20 ~ 50°C (-4 ~ 122°F)		
Charge Method	Float use: 13.7~13.9V at 25°C (77°F), recom 13.8V		
	Cycle use: 14.7~14.9V at 25°C (77°F), recom 14.7V		
	Max charge current 21.0A		
Self Discharge	Fully charged Kaise Electric Vehicle batteries may be stored for up to 6 months at 25°C (77°F) and then a freshening charge is required. For higher temperatures the time interval will be shorter.		

## Applications

- Electric wheelchair
- Electric vehicle / golf car
- Electric toys
- Renewable energies
- Marine equipment

## Certifications

ISO 9001:2008 ISO 14001:2008



## Discharge Current vs. Discharge Voltage

Final discharge voltage V/CELL	1.8	1.75	1.7	1.6
Discharge current (A)	I ≤ 0.1CA	0.25CA ≥ I > 0.1CA	0.55CA ≥ I > 0.25CA	I > 0.55CA

## Constant Current Discharge (Amperes) at 25°C (77°F)

Volts/cell	5min	15min	30min	1h	2h	3h	10h	20h
1.80V	342	205	134	80.8	46.7	35.0	11.7	6.36
1.75V	382	220	140	82.9	47.5	35.3	11.8	6.40
1.70V	415	227	141	84.1	48.3	35.6	11.9	6.42
1.65V	433	232	143	84.8	48.6	36.2	12.0	6.46
1.60V	446	240	146	85.3	48.9	36.5	12.1	6.49

## Constant Power Discharge (Watts per cell) at 25°C (77°F)

Volts/cell	5min	15min	30min	1h	2h	3h	10h	20h
1.80V	613	385	254	156	91.1	67.0	23.2	12.8
1.75V	668	407	260	157	91.3	67.3	23.4	12.8
1.70V	716	410	261	159	91.8	67.7	23.6	12.9
1.65V	720	415	261	160	92.2	68.0	23.9	13.0
1.60V	748	422	264	161	92.5	68.9	24.1	13.0

(Note) The above characteristics data are average values obtained within three charge/discharge cycles not the minimum values.

## Discharging Characteristic

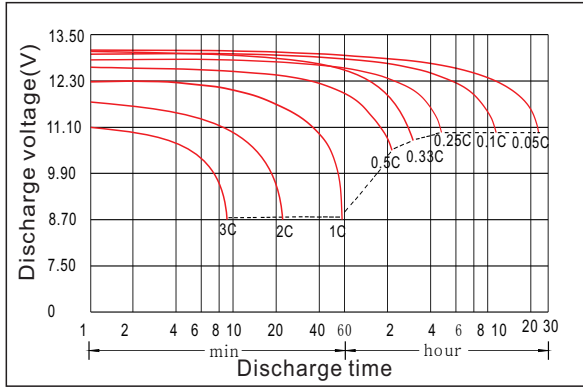

## Charging Characteristics

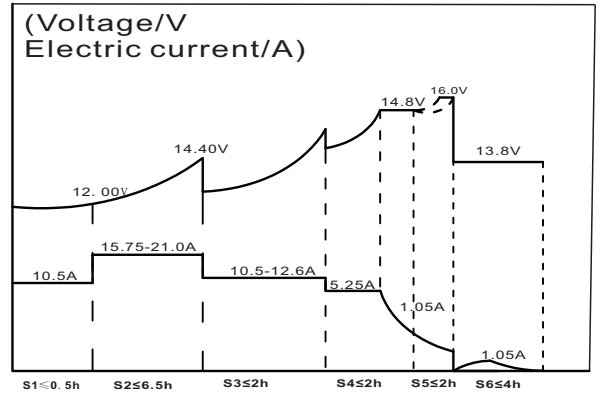

## The effect of discharge depth on cycle life

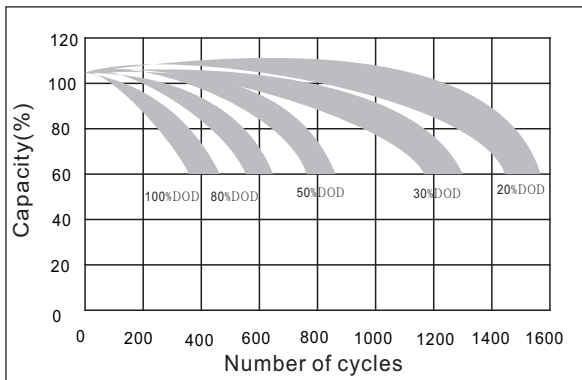

## Temperature Effects on Capacity

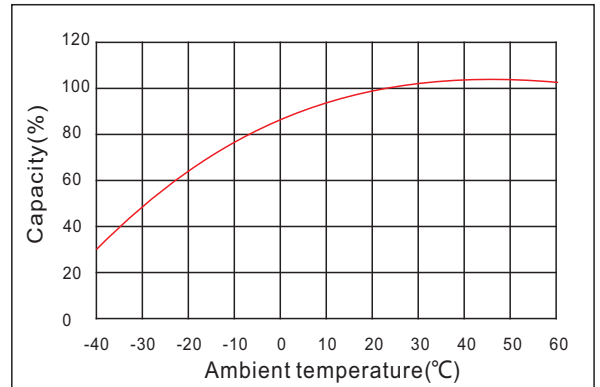

## Curves of self-discharge

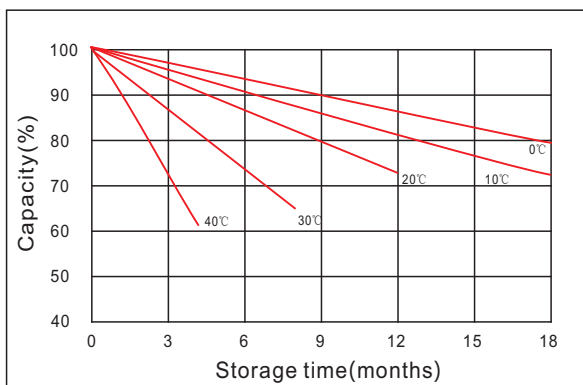

## Curves of open circuit voltage vs. capacity

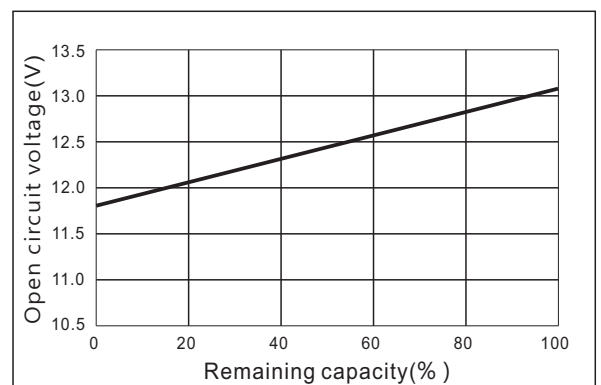

IMPORTANT NOTE: The specifications presented herein are subject to revision without notice.

