

# KBLI24500 24V 50Ah



**Longer Cycle Life:** Offers up to 20 times longer cycle life and five times longer float/calendar life than lead acid battery, helping to minimize replacement cost and reduce total cost of ownership.

**Lighter Weight:** About 40% of the weight of a comparable lead acid battery. A 'drop in' replacement for lead acid batteries.

**Higher Power:** Delivers twice power of lead acid battery, even high discharge rate, while maintaining high energy capacity.

**Wider Storage Temperature Range:** -20 °C-60 °C.

**Superior Safety:** Prismatic Lithium Iron Phosphate chemistry eliminates the risk of explosion or combustion due to high impact, overcharging or short circuit situation.

## Performance Characteristics

Nominal Voltage	25.6V
Nominal Capacity	50Ah
Energy	1,28kWh
Cycle Life	>3500 cycles at 80%DoD
Efficiency of charge	100% @ 0.5C
Efficiency of Discharge	96-99% @ 1C
Charge Voltage	29.2V
Charge Mode	@0.2C(A) to 29.2V, then @29.2V till charge current <0.05C(A) (CC/CV)
Charge Current	10 (0.2C)
Max. Charge Current	50A
Max. Discharge Current	50A
Discharge Cut-off Voltage	22.4V
Operating Humidity	0-95% RH (No condensing)
Operating Temperature range	Charge: 0 ~+50°C Discharge: -20 ~+55°C
Storage Temperature range	-20 ~+60°C / -4 ~+140°C
IP Class	IP65
Plastic Case	ABS
Approx. Dimensions	330mm*172mm*214mm (12.99in.*6.77in.*8.42in.)
Approx. Weight	15kg (33.07lbs)
Terminal	M8
Communication Interface	/
BMS Functions	Cell Voltage/Current Balance, Temperature, MOSFETS
Protection	Over voltage, Low voltage, Over Temperature, Short circuit
Certification	UN38.3, CE
Parallels Support	Support. According to user manual for parallel connection
Series Support	No Support <sup>3</sup>

## Physical Dimension-mm

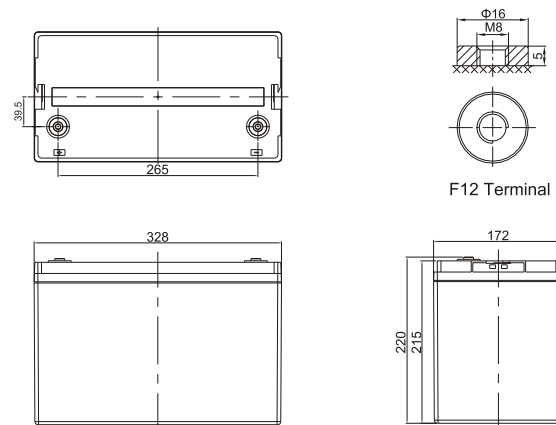

## Applications

Wheelchairs and scooters  
Solar / wind energy storage  
Back-up power for small  
UPS Golf trolleys & buggies  
Electric bikes  
Tools

(Note) The above characteristics data are average values obtained within three charge/discharge cycles not the minimum values.

# KBLI24500 24V 50h



## Charging Characteristics - 1 C@25°C

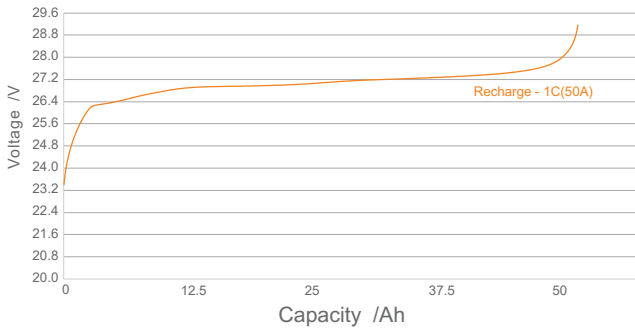

## State of Discharge Curve - 0.5C, 1 C@25°C

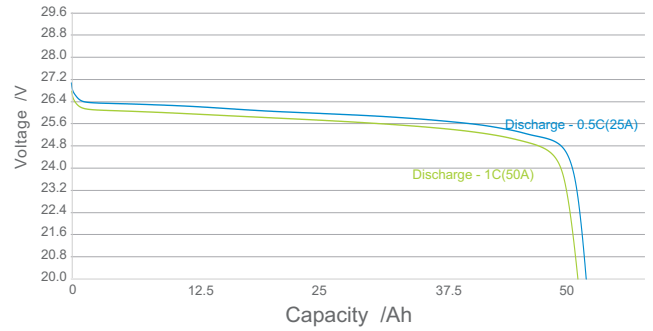

## Capacity With Different Temperature

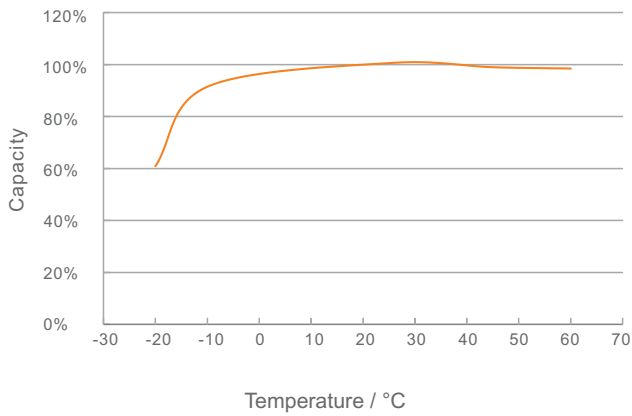

## Typical Recharge Time

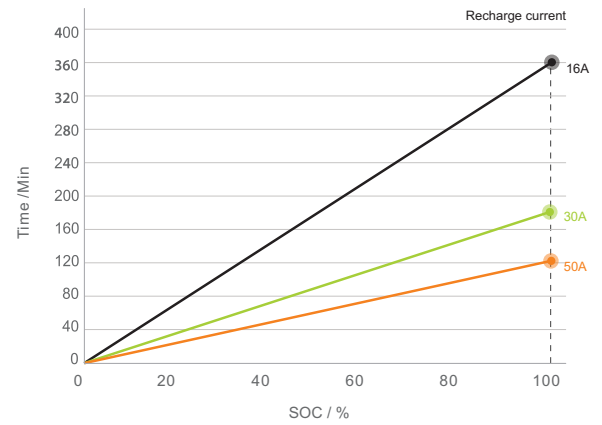

## Different Temperature Self Discharge Curve

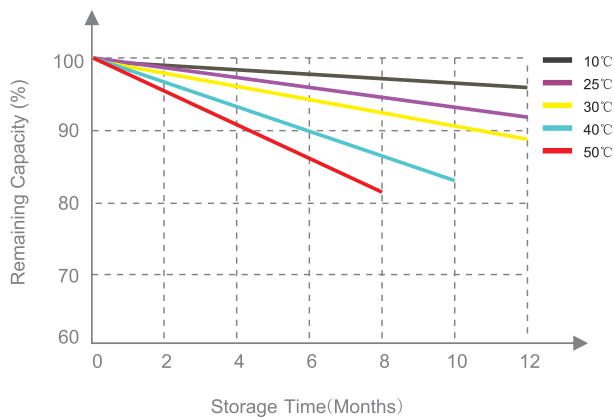

## Typical Cycle Life

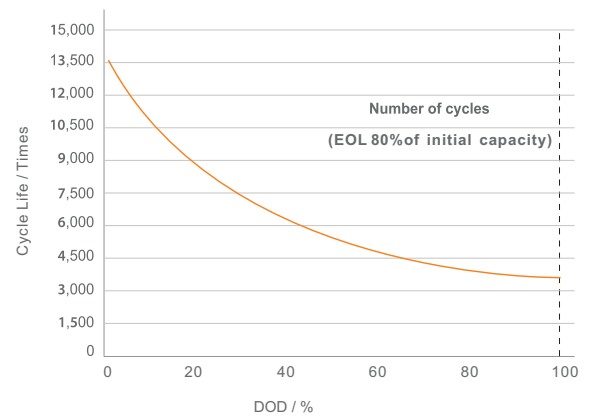

IMPORTANT NOTE: The specifications presented herein are subject to revision without notice.

Contacto  
[energy@tempelgroup.com](mailto:energy@tempelgroup.com)  
[www.tempelgroup.com](http://www.tempelgroup.com)

Tempel Group en el mundo  
 BARCELONA • MADRID • VALENCIA • BILBAO • SEVILLA • LISBOA • PORTO • BUENOS AIRES • LIMA  
 SANTIAGO DE CHILE • BOGOTÁ • SÃO PAULO • CIUDAD DE MÉXICO • CIUDAD DE PANAMÁ • MONTEVIDEO • QUITO

