



DEEP CYCLE AGM TECHNOLOGY

LDC6-224-GC2 BCI GROUP GC2

FEATURES & BENEFITS

- True deep cycle AGM technology-GREEN SOLUTION
- Over 99.99% virgin lead for grid plate and active material
- Heavy duty grid/paste design for deep cycle application
- Maintenance free, non-spillable, valve-regulated
- Double separator configuration: long cycle life & High energy density and super anti-vibration design
- Low self-discharge for longer shelf life



ELECTRICAL SPECIFICATIONS

Voltage(V)	Capacity (AH)					Reserve Capacity (Min)		
	100HR	20HR	10HR	5HR	3HR	@25A	@56A	@75A
6	246	224	210	192	173	490	188	135

PHYSICAL SPECIFICATIONS

Model	Dimensions (mm/inches)				Weight (kg/lbs)	Terminal Type (Standard)	Case Material
	Length	Width	Height	Total Height			
LDC6-224-GC2	260 (10.24)	180 (7.09)	247 (9.72)	253 (9.96)	30.5 (67.3)	T11	ABS

Operating Temperature Range		
Discharge	Charge	Storage
-15°C ~ 50°C (5°F ~ 122°F)	0°C ~ 40°C (32°F ~ 104°F)	-15°C ~ 40°C (5°F ~ 104°F)

LDC6-224-GC2

DIMENSIONS

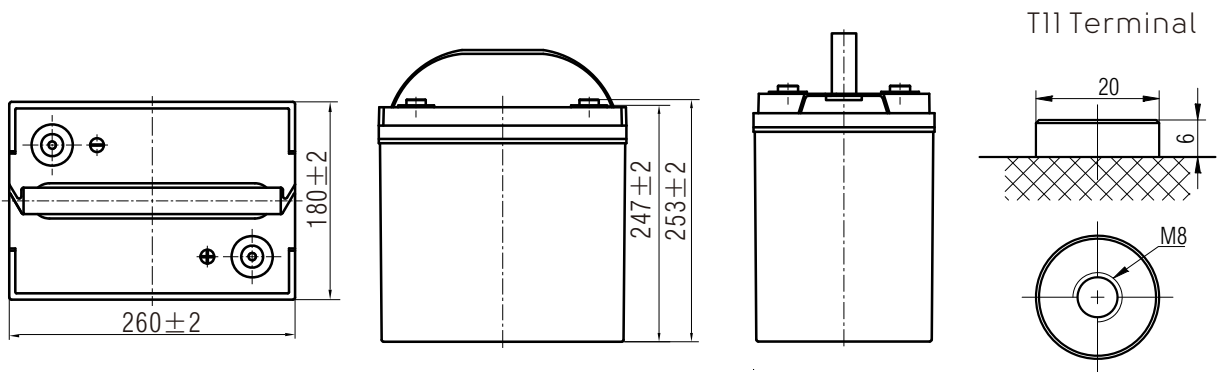

Note: Terminal Torque Values in-lb(Nm) : 97.28-130.0(11-14.7)

PERFORMANCE CHARACTERISTICS

LEOCH LDC AGM Charging Profile

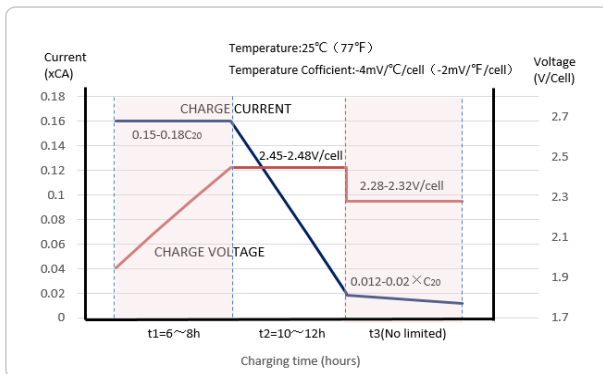

Relationship of OCV and State Of Charge (25°C, 77°F)

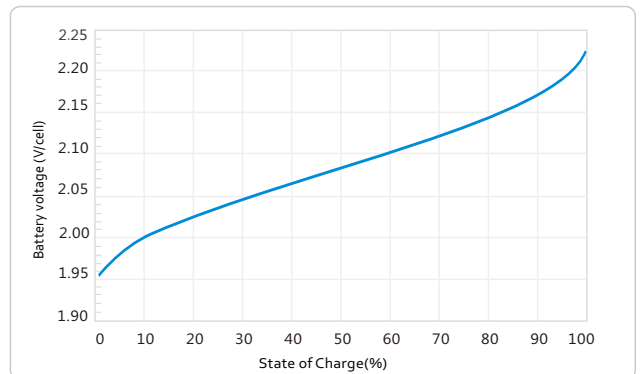

Cycle life in relation to Depth Of Discharge

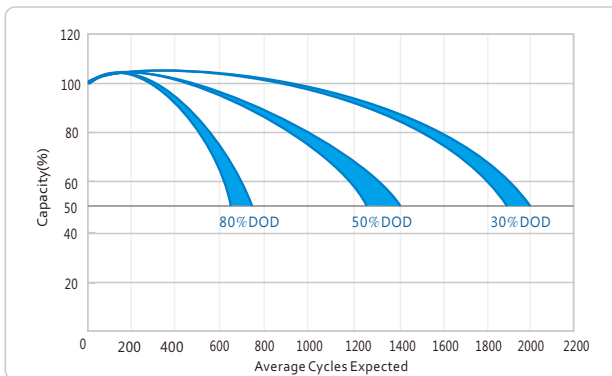

Self-discharge Characteristic

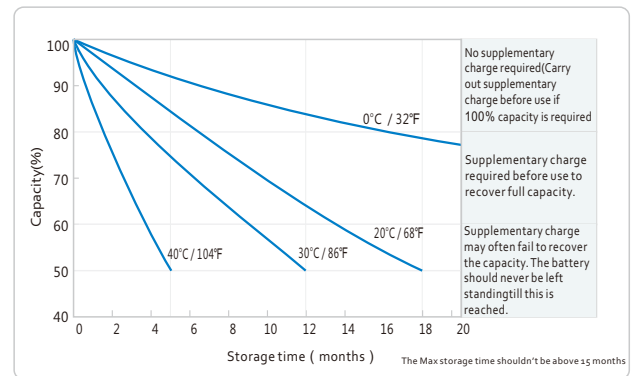

● LEOCH INTERNATIONAL SALES OFFICE:
Add: 5th Floor, Xinbaohui Bldg.
Nanhai Blvd, Nanshan, Shenzhen, China. 518054
Tel: +86-755-86036060(100 lines) Fax: +86-755-26067269
E-mail: export@leoch.com
web: www.leoch.com

© 2018 LEOCH. All rights reserved. Trademarks and logos are the property of LEOCH and its affiliates unless otherwise noted. Subject to revisions without prior notice.

Publication No: LB-LDC-PD-EN-V1.0-201807