

Specification

Nominal Voltage	12V	
Nominal Capacity(20HR)	50.0Ah	
Dimension	Length	197 ± 2mm
	Width	165 ± 2mm
	Container Height	170 ± 2mm
	Total Height with Terminal	170 ± 2mm
Approx Weight	Approx 14.5 kg	
Terminal	T6	
Container Material	ABS	
Rated Capacity	50.0 Ah/2.50A	(20hr, 1.75V/cell, 25°C)
	45.5 Ah/4.55A	(10hr, 1.75V/cell, 25°C)
	39.3 Ah/7.86A	(5hr, 1.70V/cell, 25°C)
	34.5 Ah/11.5A	(3hr, 1.70V/cell, 25°C)
	26.9 Ah/26.9A	(1hr, 1.60V/cell, 25°C)
Max. Discharge Current	540A (5s)	
Internal Resistance	Approx 9mΩ	
Operating Temp. Range	Discharge	-20 ~ 55°C
	Charge	0 ~ 40°C
	Storage	-20 ~ 50°C
Nominal Operating Temp. Range	25 ± 3° C	
Cycle Use	Initial Charging Current less than 13.5A. Voltage	
	14.4V~15.0V at 25°C Temp. Coefficient -30mV/°C	
Standby Use	No limit on Initial Charging Current Voltage	
	13.5V~13.8V at 25°C Temp. Coefficient -20mV/°C	
Capacity affected by Temperature	40° C	103%
	25° C	100%
	0° C	86%
Self Discharge	PBCG series batteries may be stored for up to 9 months at 25° C and then a freshening charge is required. For higher temperatures the time interval will be shorter.	



Applications

- ◆ Telecommunications
- ◆ Solar system
- ◆ Wind power system
- ◆ Wheelchair
- ◆ Floor cleaning machines
- ◆ Golf trolley
- ◆ Boats

Intertek



Constant Current Discharge (Amperes) at 25 °C (77°F)

F.V/Time	5min	10min	15min	20min	30min	45min	1h	2h	3h	4h	5h	6h	8h	10h	20h
1.85V/cell	72.5	57.0	48.5	40.6	32.1	24.4	20.1	12.8	10.0	8.18	6.95	6.05	4.93	4.18	2.38
1.80V/cell	96.0	71.8	57.8	47.3	36.9	27.6	22.4	13.9	10.7	8.71	7.47	6.50	5.25	4.50	2.45
1.75V/cell	110.4	80.5	64.4	51.9	39.3	29.2	23.7	14.6	11.1	9.00	7.65	6.68	5.34	4.55	2.50
1.70V/cell	123.0	88.8	69.5	55.2	41.5	30.7	24.7	15.3	11.5	9.27	7.86	6.82	5.42	4.57	2.54
1.65V/cell	134.4	94.9	73.2	58.0	43.5	31.6	25.6	15.7	11.9	9.55	8.04	6.97	5.50	4.61	2.57
1.60V/cell	149.4	103.9	79.0	62.3	46.2	33.4	26.9	16.3	12.3	9.77	8.19	7.12	5.57	4.69	2.60

Constant Power Discharge (Watts/cell) at 25 °C (77°F)

F.V/Time	5min	10min	15min	20min	30min	45min	1h	2h	3h	4h	5h	6h	8h	10h	20h
1.85V/cell	133.7	106.2	91.2	77.1	61.4	47.0	39.0	25.0	19.5	16.0	13.7	11.9	9.77	8.30	4.47
1.80V/cell	175.1	132.2	107.2	88.5	69.8	53.0	43.2	27.0	20.8	17.0	14.6	12.8	10.4	8.92	4.60
1.75V/cell	197.0	145.8	118.0	96.2	73.8	55.5	45.5	28.2	21.5	17.5	15.0	13.1	10.5	9.00	4.64
1.70V/cell	213.1	156.9	125.5	101.3	77.3	58.0	47.3	29.5	22.2	18.0	15.3	13.3	10.7	9.04	4.73
1.65V/cell	228.9	165.8	130.8	105.6	80.2	59.2	48.6	30.1	22.9	18.5	15.6	13.6	10.8	9.11	4.77
1.60V/cell	248.7	177.3	138.7	112.2	84.5	62.2	50.7	31.0	23.6	18.8	15.9	13.8	10.9	9.25	4.80

Dimensions

T6 Terminal

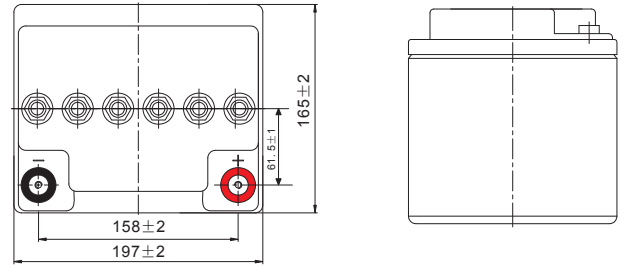
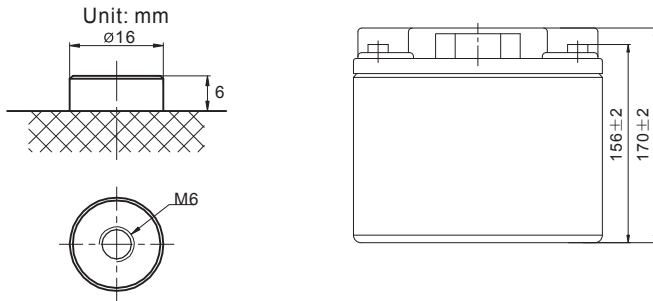

Discharge Characteristics

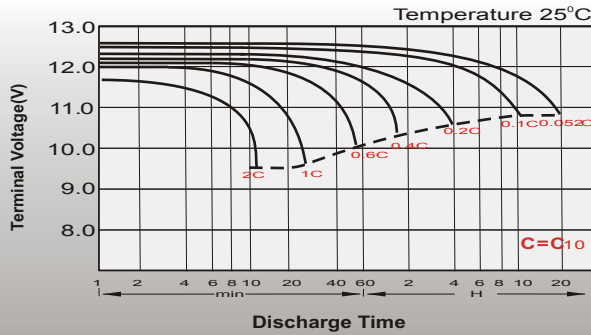

Float Charging Characteristics

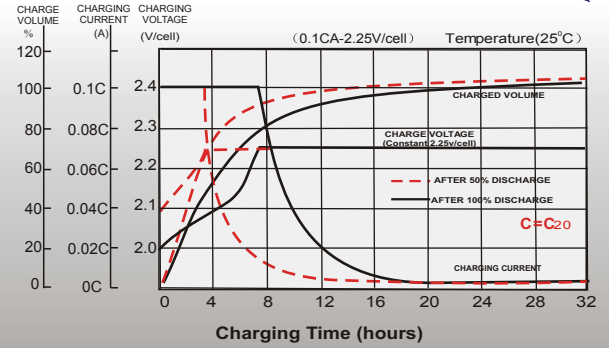

Temperature Effects in Relation to Battery Capacity

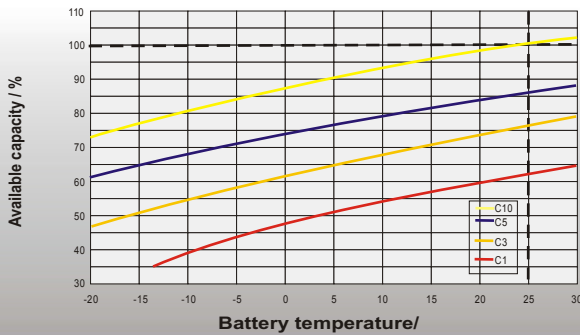

Effect of Temperature on Long Term Float Life

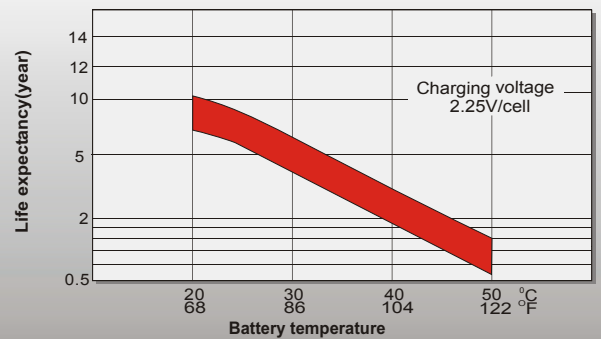

Cycle Life in Relation to Depth of Discharge

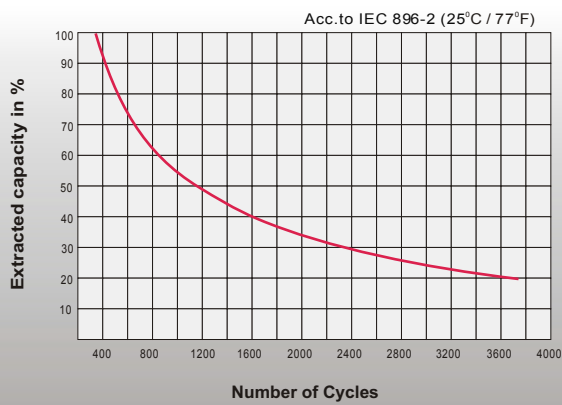

General Relation of Capacity VS. Storage Time

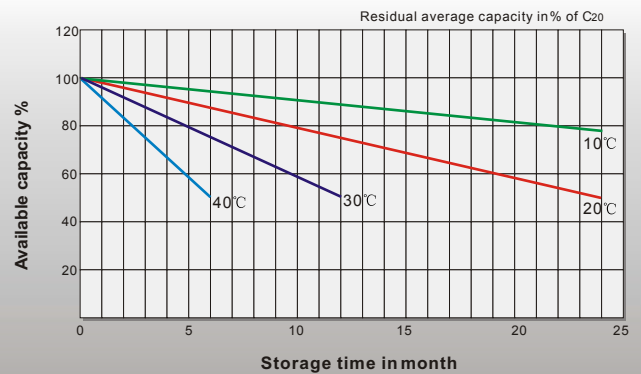

Contact